

Karta katalogowa

Wentylator VKP/VKPI do systemów prostokątnych

Seria
VKP



Seria
VKPI



Kanałowy wentylator odśrodkowy do prostokątnych kanałów wentylacyjnych w obudowie z ocynkowanej stali. Modele VKPI posiadają dodatkowo izolację akustyczną i termiczną o grubości 50 mm. Wydajność do **2 970 m³/h**.

Zastosowanie

Kanałowe wentylatory odśrodkowe serii VKP/VKPI są wykorzystywane w nawiewno-wywiewnej wentylacji pojedynczych pomieszczeń, budynków indywidualnych, zbiorowego zamieszkania i użyteczności publicznej. Do wentylacji z podwyższonymi wymaganiami dotyczącymi poziomu hałasu proponowane są warianty w izolowanej obudowie.

Wentylatory przeznaczone są do łączenia się z prostokątnymi przewodami wentylacyjnymi o przekroju nominalnym: 400x200, 500x250, 500x300, 600x300, 600x350 mm.

Konstrukcja

Obudowa wentylatora jest wykonana z ocynkowanej stali. Modele VKPI posiadają dodatkowo izolację akustyczną i termiczną z wełny mineralnej o grubości 50 mm.

Silnik

W wentylatorach są zastosowane dwu- i cztero-biegowe asynchroniczne silniki z zewnętrznym wirnikiem o łopatkach zagiętych do tyłu. Silniki mają wbudowane zabezpieczenie zapobiegające jego przegrzaniu wraz z automatycznym restartem. W celu osiągnięcia dłuższego okresu eksploatacji stosuje się łożyska kulkowe. Dla uzyskania odpowiednich parametrów i bezpiecznej pracy wentylatora podczas procesu montażu każda turbina przechodzi dynamiczne wyważanie co zapewnia m.in. niski poziom szumu pracy wentylatora. Stopień ochrony: IP X4.

Regulacja prędkości

Regulowanie prędkości może odbywać się w sposób płynny (regulator tyrystorowy) jak również skokowy (regulator transformatorowy). Wentylatory mogą być podłączone po parę jednostek do jednego sterownika pod warunkiem, że dostępna moc i prąd nie będą przewyższać nominalnych parametrów regulatora.

Montaż

Możliwy jest montaż pod dowolnym kątem względem osi wentylatora. Przyłączenie elektryczne i instalacja powinny być wykonane zgodnie z instrukcją i elektrycznym schematem znajdującym się w DTR. W celu wyeliminowania drgań, wentylatory powinny być połączone z systemem wentylacyjnym za pośrednictwem łączników elastycznych. W wentylatorze serii VKPI przewidziana jest uchylna pokrywka w obudowie umożliwiająca kontrolę.

Seria	
VKP	I – obudowa izolowana

Wymiary kanału – szer. x wys. [mm]
400x200, 500x250, 500x300, 600x300, 600x350

Wersje silnika	
Ilość biegunów	Ilość faz
4	E – jednofazowy
2	D – trzyczonowy

Akcesoria



str. 366



str. 308



str. 368

Regulatory



str. 200

Dane techniczne

	VKP / VKPI 2E 400x200	VKP / VKPI 2E 500x250	VKP / VKPI 4E 500x300	VKP / VKPI 4D 500x300
Napięcie [V]	230	230	230	400
Moc [W]	138	305	140	136
Pobór prądu [A]	0,60	1,32	0,57	0,34
Wydajność [m ³ /h]	930	1720	1700	1380
Obroty [min ⁻¹]	2600	2550	1390	1360
Poziom ciśnienia akustycznego [dB(A)/3 m]	69 / 61*	76 / 65*	53 / 45*	53 / 45*
Temperatura pracy [°C]	-25 +45	-25 +45	-25 +45	-25 +65
Stopień ochrony	IPX4	IPX4	IPX4	IPX4

	VKP / VKPI 4E 600x300	VKP / VKPI 4D 600x300	VKP / VKPI 4E 600x350	VKP / VKPI 4D 600x350
Napięcie [V]	230	400	230	400Δ 400Y
Moc [W]	220	230	470	510 380
Pobór prądu [A]	0,90	0,52	2,37	1,41 0,70
Wydajność [m ³ /h]	2470	2530	2950	2970 2660
Obroty [min ⁻¹]	1400	1360	1370	1415 1235
Poziom ciśnienia akustycznego [dB(A)/3 m]	55 / 47*	53 / 46*	67 / 59*	64 / 55* 63 / 55*
Temperatura pracy [°C]	-25 +45	-25 +70	-40 +80	-40 +60 -40 +80
Stopień ochrony	IPX4	IPX4	IPX4	IPX4

* parametry dla wentylatora VKPI

Wymiary wentylatorów

Typ	Wymiary [mm]								Waga [kg]
	B	B1	B2	H	H1	H2	H3	L	
VKP 2E 400x200	400	420	440	200	220	240	240	500	11,25
VKP 2E 500x250	500	520	540	250	270	290	290	640	17,88
VKP 4E 500x300	500	520	540	300	320	340	340	680	19,8
VKP 4D 500x300	500	520	540	300	320	340	340	680	19,8
VKP 4E 600x300	600	620	640	300	320	340	342	680	27,77
VKP 4D 600x300	600	620	640	300	320	340	342	680	27,77
VKP 4E 600x350	600	620	640	350	370	390	390	735	36,38
VKP 4D 600x350	600	620	640	350	370	390	390	735	36,38

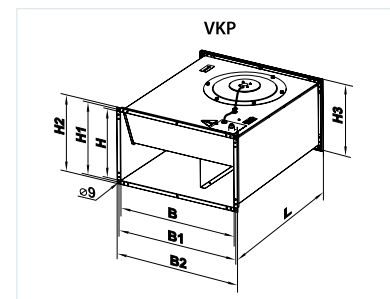

Wymiary wentylatorów

Typ	Wymiary [mm]									Waga [kg]
	B	B1	B2	B3	H	H1	H2	H3	L	
VKPI 2E 400x200	400	420	440	500	200	220	240	360	500	24,5
VKPI 2E 500x250	500	520	540	600	250	270	290	410	640	27,6
VKPI 4E 500x300	500	520	540	600	300	320	340	460	680	37,2
VKPI 4D 500x300	500	520	540	600	300	320	340	460	680	37,2
VKPI 4E 600x300	600	620	640	700	300	320	340	460	680	43,5
VKPI 4D 600x300	600	620	640	700	300	320	340	460	680	43,5
VKPI 4E 600x350	600	620	640	700	350	370	390	530	735	56,2
VKPI 4D 600x350	600	620	640	700	350	370	390	530	735	56,2

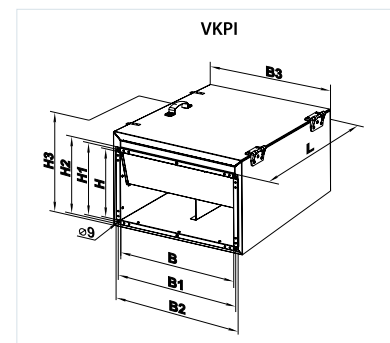

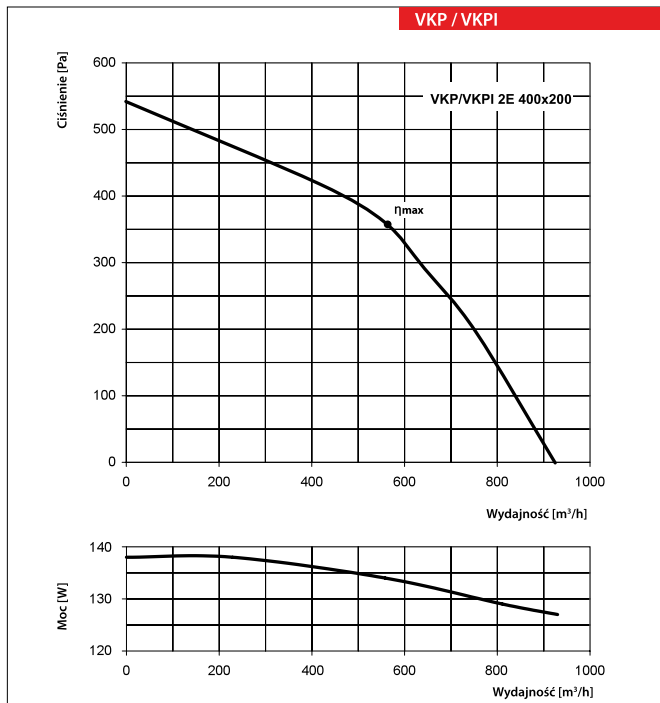

VKP 2E 400x200

Poziom mocy akustycznej		Pasma częstotliwości, [Hz]								
	Hz	Gen	63	125	250	500	1000	2000	4000	8000
L _{WA} wlot	dBA	71	54	63	68	64	64	58	54	45
L _{WA} wylot	dBA	75	53	62	66	68	69	66	60	48
L _{WA} emitowane	dBA	58	36	48	56	54	50	46	41	32

VKPI 2E 400x200		Pasma częstotliwości, [Hz]								
	Hz	Gen	63	125	250	500	1000	2000	4000	8000
L _{WA} wlot	dBA	65	45	57	60	60	57	53	49	43
L _{WA} wylot	dBA	70	47	59	61	66	64	60	55	43
L _{WA} emitowane	dBA	48	26	37	45	43	35	32	29	22

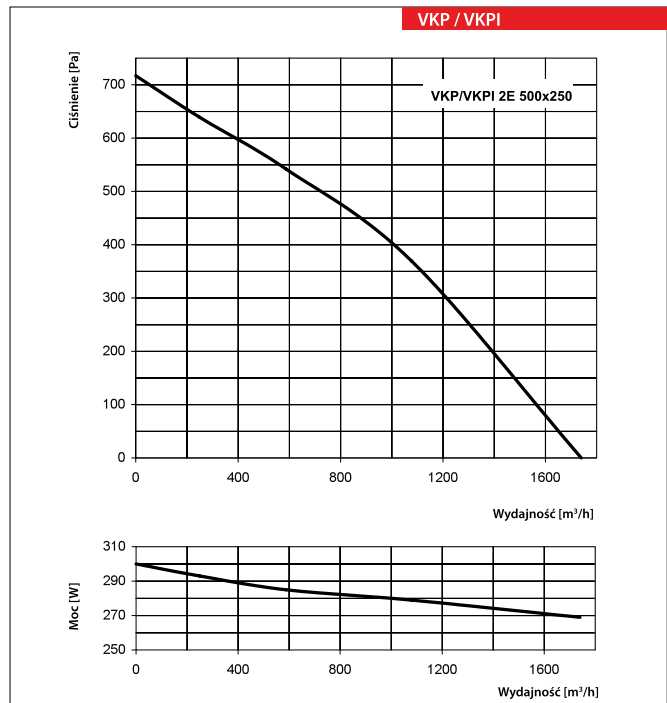

VKP 2E 500x250

Poziom mocy akustycznej		Pasma częstotliwości, [Hz]								
	Hz	Gen	63	125	250	500	1000	2000	4000	8000
L _{WA} wlot	dBA	69	60	68	60	56	56	49	46	46
L _{WA} wylot	dBA	70	54	65	64	63	60	56	49	44
L _{WA} emitowane	dBA	53	41	48	47	44	40	38	33	35

VKPI 2E 500x250		Pasma częstotliwości, [Hz]								
	Hz	Gen	63	125	250	500	1000	2000	4000	8000
L _{WA} wlot	dBA	62	52	60	56	51	50	43	42	40
L _{WA} wylot	dBA	63	48	59	60	55	57	53	45	39
L _{WA} emitowane	dBA	41	27	35	37	31	29	27	25	27

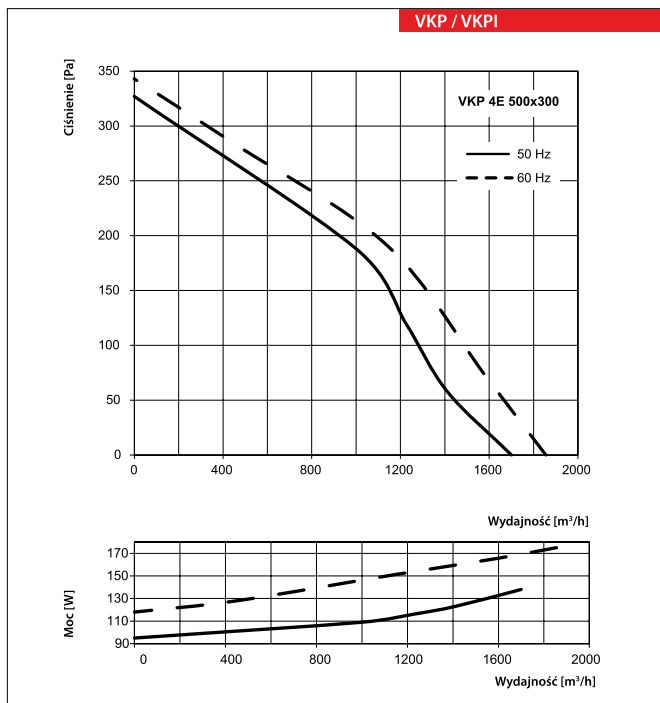

VKP 4E 500x300

Poziom mocy akustycznej		Pasma częstotliwości, [Hz]								
	Hz	Gen	63	125	250	500	1000	2000	4000	8000
L _{WA} wlot	dBA	69	58	63	64	55	57	58	51	46
L _{WA} wylot	dBA	73	57	60	72	65	65	64	57	48
L _{WA} emitowane	dBA	56	44	52	51	51	49	48	43	33

VKPI 4E 500x300		Pasma częstotliwości, [Hz]								
	Hz	Gen	63	125	250	500	1000	2000	4000	8000
L _{WA} wlot	dBA	64	51	59	60	48	55	51	49	40
L _{WA} wylot	dBA	70	50	55	64	59	62	59	50	43
L _{WA} emitowane	dBA	44	31	37	40	39	38	35	32	20

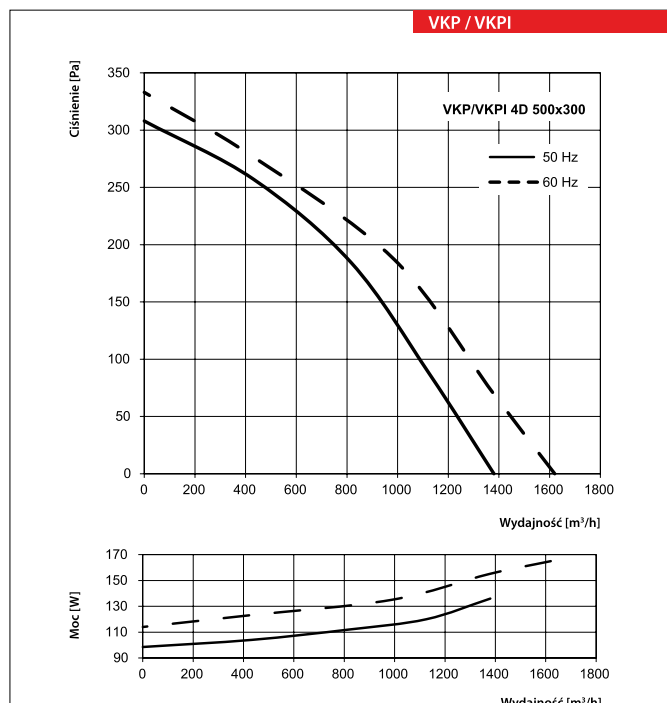

VKP 4D 500x300

Poziom mocy akustycznej		Pasma częstotliwości, [Hz]								
	Hz	Gen	63	125	250	500	1000	2000	4000	8000
L _{WA} wlot	dBA	69	58	62	65	55	58	58	55	45
L _{WA} wylot	dBA	71	56	62	69	64	66	63	59	50
L _{WA} emitowane	dBA	55	42	51	51	52	52	48	43	32

VKPI 4D 500x300		Pasma częstotliwości, [Hz]								
	Hz	Gen	63	125	250	500	1000	2000	4000	8000
L _{WA} wlot	dBA	62	51	59	63	49	55	54	49	39
L _{WA} wylot	dBA	66	51	57	67	59	63	60	50	42
L _{WA} emitowane	dBA	44	31	38	38	38	36	38	31	22

VKP / VKPI

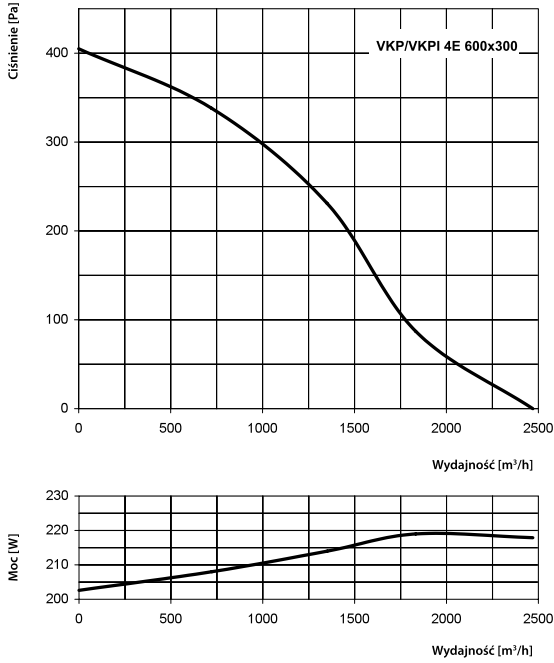

VKP 4E 600x300

Poziom mocy akustycznej		Pasma częstotliwości, [Hz]								
	Hz	Gen	63	125	250	500	1000	2000	4000	8000
L_{WA} wlot	dBA	72	63	67	69	56	61	61	54	48
L_{WA} wylot	dBA	78	57	65	73	68	69	69	61	54
L_{WA} emitowane	dBA	61	43	55	54	55	53	49	48	35

VKPI 4E 600x300		Pasma częstotliwości, [Hz]								
	Hz	Gen	63	125	250	500	1000	2000	4000	8000
L_{WA} wlot	dBA	68	58	62	64	55	55	53	51	42
L_{WA} wylot	dBA	71	54	60	67	62	64	61	54	49
L_{WA} emitowane	dBA	48	34	42	43	41	40	37	36	23

VKP / VKPI

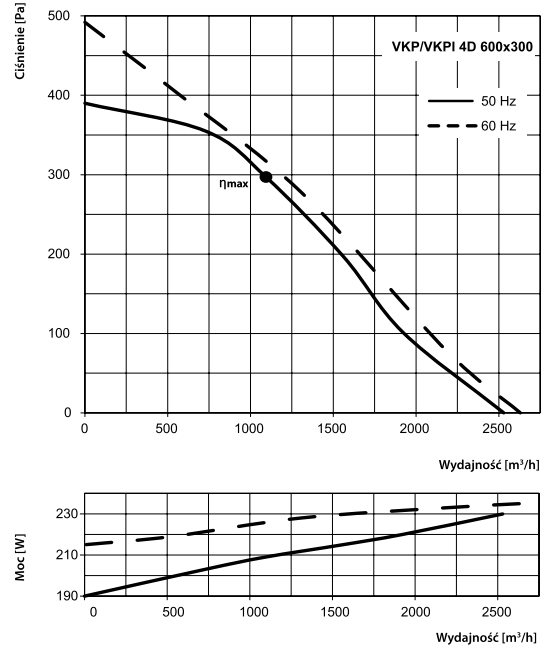

VKP 4D 600x300

Poziom mocy akustycznej		Pasma częstotliwości, [Hz]								
	Hz	Gen	63	125	250	500	1000	2000	4000	8000
L_{WA} wlot	dBA	72	61	69	67	60	62	58	56	50
L_{WA} wylot	dBA	76	59	66	73	68	69	66	58	51
L_{WA} emitowane	dBA	59	45	53	56	54	54	53	47	38

VKPI 4D 600x300		Pasma częstotliwości, [Hz]								
	Hz	Gen	63	125	250	500	1000	2000	4000	8000
L_{WA} wlot	dBA	69	55	60	66	53	55	56	52	43
L_{WA} wylot	dBA	71	56	61	70	62	65	60	55	45
L_{WA} emitowane	dBA	46	31	43	41	40	41	40	35	23

VKP / VKPI

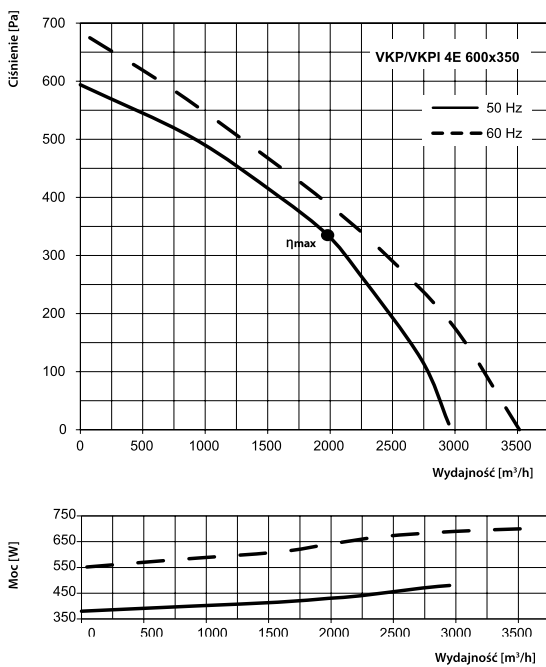

VKP 4E 600x350

Poziom mocy akustycznej		Pasma częstotliwości, [Hz]								
	Hz	Gen	63	125	250	500	1000	2000	4000	8000
L_{WA} wlot	dBA	78	58	78	75	60	64	65	67	55
L_{WA} wylot	dBA	79	58	69	75	67	70	69	69	56
L_{WA} emitowane	dBA	64	37	61	55	51	54	49	43	35

VKPI 4E 600x350		Pasma częstotliwości, [Hz]								
	Hz	Gen	63	125	250	500	1000	2000	4000	8000
L_{WA} wlot	dBA	75	53	72	71	54	58	63	60	52
L_{WA} wylot	dBA	74	52	62	69	62	67	65	64	54
L_{WA} emitowane	dBA	51	25	51	44	40	42	38	34	23

VKP / VKPI

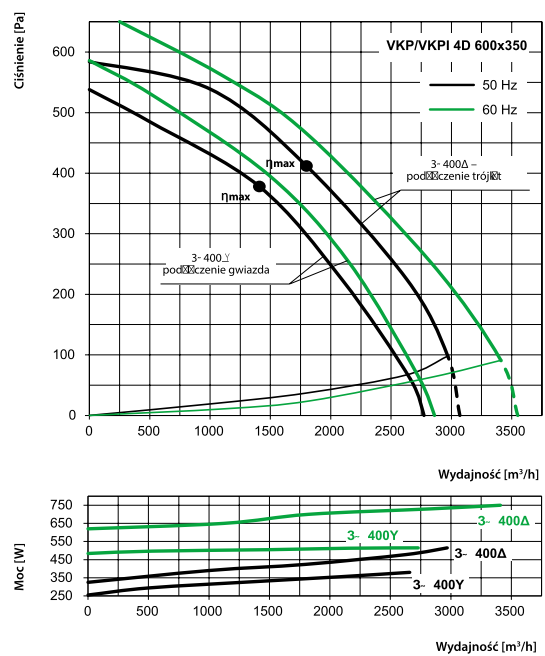































































VKP 4D 600x350

Poziom mocy akustycznej		Pasma częstotliwości, [Hz]								
	Hz	Gen	63	125	250	500	1000	2000	4000	8000
L_{WA} wlot	dBA	72	57	59	72	66	64	65	58	47
L_{WA} wylot	dBA	81	60	67	76	74	74	69	59	50
L_{WA} emitowane	dBA	65	40	53	61	57	55	54	47	38

VKPI 4D 600x350		Pasma częstotliwości, [Hz]								
	Hz	Gen	63	125	250	500	1000	2000	4000	8000
L_{WA} wlot	dBA	70	54	56	65	62	60	58	49	40
L_{WA} wylot	dBA	74	57	63	73	70	68	65	57	47
L_{WA} emitowane	dBA	52	27	41	50	43	45	41	35	26

TABELA KOMPATYBILNOŚCI WENTYLATORÓW I STEROWNIKÓW

																								
		WP 300x150 M1/L1 EC	WP 400x200 M1/L1 EC	WP 500x250 M1/L1 EC	WP 500x300 L1 EC	WP 600x300 M1 EC	WP 600x350 L3/M1 EC	WP 700x400 L2/M1 EC	WP 800x500 L3/M3 EC	WP 900x500 L3 EC	WP 1000x500 L3 EC	WP 2E 400x200	WP 2E 400x200	WP 2E 500x250	WP 2E 500x250	WP 4E 500x300	WP 4E 500x300	WP 4D 500x300	WP 4D 500x300	WP 4E 600x350	WP 4E 600x350	WP 4D 600x350	WP 4D 600x350	
Regulatory prędkości tyrystorowe																								
	RS-1-300																							
	RS-1-400																							
	SRS-1																							
	RS-1 N (W)																							
	RS-1.5 N (W)																							
	RS-2.0 N (W)																							
	RS-2.5 N (W)																							
	AREB 2,5																							
	ARE 3,0																							
	ARES 5,0																							
	ARES 7,0																							
	ARES 10,0																							
Regulatory prędkości autotransformatorowe																								
	ARW 0,5																							
	ARW 1,5/5																							
	ARW 2,0/5																							
	ARW 3,0/5																							
	ARW 5,0/5																							
	ARW 7,0/5																							
	ARW 10,0/5																							
	ARWD 1,5																							
	ARWD 3,0																							
	ARWD 5,0																							
	ARWD 7,0																							
	ARWD 10,0																							
	ARWD 14,0																							
	A3RW 1,5																							
	A3RW 2,0																							
	A3RW 4,0																							
	A3RW 5,0																							
	A3RW 7,0																							
	A3RW 10,0																							
	A3RW 14,0																							
	A3RWD 1,5																							
	A3RWD 2,0																							
	A3RWD 4,0																							
	A3RWD 5,0																							
	A3RWD 7,0																							
	A3RWD 10,0																							
	A3RWD 14,0																							
Regulatory do silników EC																								
	R-1/010																							
Regulatory temperaturowe																								
	RTS-1-400																							
	RTSD-1-400																							
	TST-1-300																							
	TSTD-1-300																							
	RT-10																							
Regulatory sterowane 0-10V DC																								
	ARWE 1,5																							
	ARWE 2,0																							
	ARWE 3,0																							
	ARWE 5,0																							
	ARWE 7,0																							
	ARWE 10,0																							
	AREX 5,0																							
	AREX 7,0																							
	AREX 10,0																							
	A3RWE 4,0																							
	A3RWE 5,0																							
	A3RWE 7,0																							
	A3RWE 10,0																							
Regulatory sterowane protokołem MODBUS RTU																								
	AREX A 5,0																							
	AREX A 7,0																							
	AREX A 10,0																							

zalecany wariant do zastosowania, możliwy wariant do zastosowania